

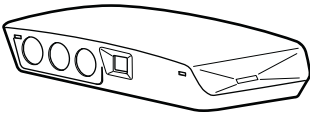

Installation manual

Daikin Altherma LAN adapter



BRP069A61
BRP069A62

Installation manual
Daikin Altherma LAN adapter

English

Table of Contents

- 1 About the documentation** **2**
- 1.1 About this document..... 2
- 2 About the product** **2**
- 3 About the box** **3**
- 3.1 To unpack the LAN adapter 3
- 4 Preparation** **3**
- 4.1 Installation site requirements..... 3
- 4.2 Overview of electrical connections 4
- 4.2.1 Router 4
- 4.2.2 Indoor unit 4
- 4.2.3 Electrical meter 4
- 4.2.4 Digital outputs 4
- 5 Installation** **4**
- 5.1 Mounting the LAN adapter 4
- 5.1.1 To mount the rear casing to the wall 5
- 5.1.2 To mount the PCB to the rear casing..... 5
- 5.2 Connecting the electrical wiring..... 5
- 5.2.1 To connect the indoor unit 5
- 5.2.2 To connect the router 6
- 5.2.3 To connect the electrical meter 6
- 5.2.4 To connect the digital outputs 6
- 5.3 Finishing the LAN adapter installation 6
- 5.3.1 LAN adapter serial number 6
- 5.3.2 To close the LAN adapter 7
- 6 Starting up the system** **7**

1 About the documentation

1.1 About this document

Target audience

Authorised installers

Documentation set

This document is part of a documentation set. The complete set consists of:

- **General safety precautions**
 - Safety instructions that you must read before installing
 - Format: Paper (in the box of the indoor unit)
- **Installation manual:**
 - Installation instructions
 - Format: Paper (supplied in the kit)
- **Installer reference guide:**
 - Installation instructions, configuration, application guidelines,...
 - Format: Digital files on <http://www.daikineurope.com/support-and-manuals/product-information/>

Latest revisions of the supplied documentation may be available on the regional Daikin website or via your dealer.

The original documentation is written in English. All other languages are translations.

Technical engineering data

- A **subset** of the latest technical data is available on the regional Daikin website (publicly accessible).

- The **full set** of latest technical data is available on the Daikin extranet (authentication required).

2 About the product

The Altherma LAN adapter allows for smartphone control of Daikin Altherma systems and, depending on the model, can be used in various Smart Grid applications, such as the storage of self-generated electrical energy as thermal energy (e.g. as domestic hot water).

The LAN adapter is available in two versions:

Model	Functionality
BRP069A61	Smartphone control + Smart Grid applications
BRP069A62	Smartphone control only

Components: casing

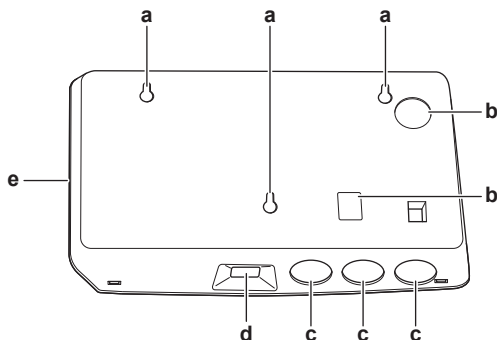

- a Wall mounting holes
- b Knockout holes (wiring from the rear)
- c Knockout holes (wiring from the bottom)
- d Ethernet connection
- e Status LEDs

Components: PCB

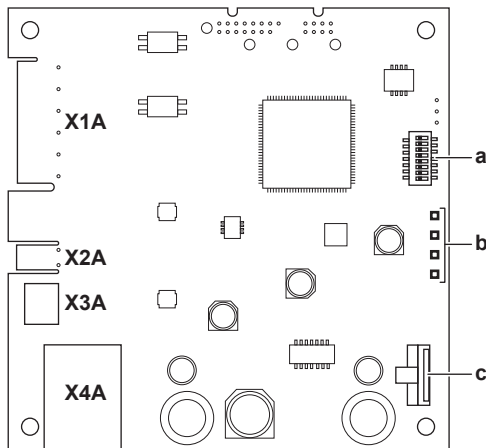

- a DIP switch
- b Status LEDs
- c microSD card slot

Status LEDs

LED	Description	Behaviour
♥	Indication of power to the adapter, and of normal operation.	<ul style="list-style-type: none"> ▪ Heartbeat: normal operation ▪ ON/OFF: no operation
□	Indication of TCP/IP communication with the router.	<ul style="list-style-type: none"> ▪ ON: normal communication ▪ Flashing: communication problem

LED	Description	Behaviour
P1P2	Indication of communication with the indoor unit.	<ul style="list-style-type: none"> ON: normal communication Flashing: communication problem
 (a)	Indication of Smart Grid activity.	ON: Smart Grid functionality of the indoor unit is controlled by the LAN adapter

(a) This LED is only active for BRP069A61 (present for BRP069A62, but always inactive).

3 About the box

3.1 To unpack the LAN adapter

1 Unpack the LAN adapter.

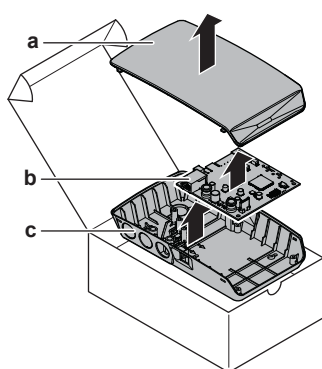

a Front casing
b PCB
c Rear casing

2 Separate the accessories.

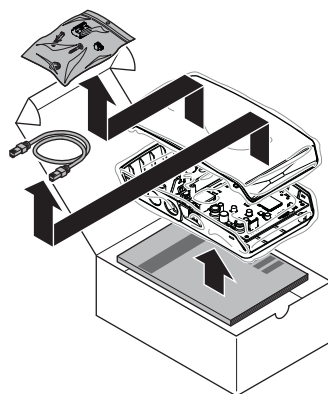

Accessories: BRP069A61

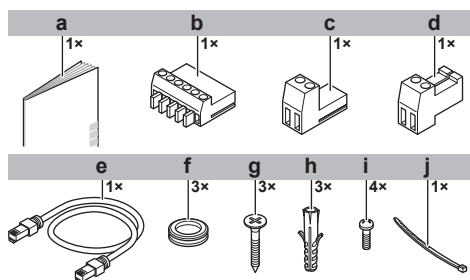

a Installation manual
b 6-pole slide connector for X1A
c 2-pole slide connector for X2A
d 2-pole plug connector for X3A
e Ethernet cable
f Grommets
g Screws to mount rear casing
h Plugs to mount rear casing
i Screws to mount PCB
j Cable tie

h Plugs to mount rear casing
i Screws to mount PCB
j Cable tie

Accessories: BRP069A62

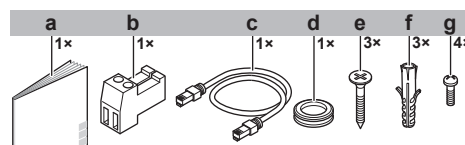

a Installation manual
b 2-pole plug connector for X3A
c Ethernet cable
d Grommet
e Screws to mount rear casing
f Plugs to mount rear casing
g Screws to mount PCB

4 Preparation

4.1 Installation site requirements



INFORMATION

Also read the maximum cable length requirements set out in "4.2 Overview of electrical connections" on page 4.

• Mind the following spacing installation guidelines:

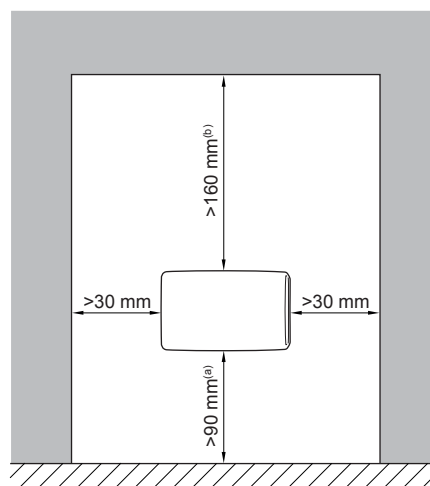

- (a) Provide enough space to connect the Ethernet cable without exceeding its minimum bend radius (typically 90 mm)
- (b) Provide enough space to open the casing with a flat-blade screwdriver (typically 160 mm)

- The LAN adapter is designed to be wall-mounted in dry, indoor locations only. Make sure the installation surface is a flat and vertical non-combustible wall.
- The LAN adapter is designed to be mounted in the following orientation only: with the PCB on the right-hand side in the casing, and the Ethernet connector facing the floor.
- The LAN adapter is designed to operate in ambient temperature ranging from 5~35°C.

5 Installation

4.2 Overview of electrical connections

Connectors

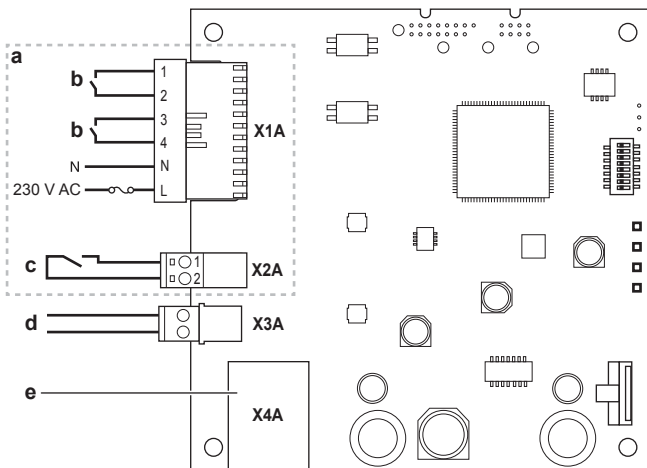

- a BRP069A61 only
- b To digital outputs of solar inverter / energy management system
- c To electrical pulse meter
- d To indoor unit
- e To router

Connections

Connection	Cable section	Wires	Maximum cable length
Accessory cables			
Router (X4A)	—	—	50/100 m ^(a)
Field-supplied cables			
Indoor unit (X3A)	0.75~1.25 mm ²	2 ^(b)	200 m
Electrical meter (X2A)	0.75~1.25 mm ²	2 ^(c)	100 m
Digital outputs (X1A)	0.75~1.5 mm ²	Depends on application ^(d)	100 m

- (a) The Ethernet cable delivered as an accessory is 1 m long. It is, however, possible to use a field-supplied Ethernet cable. In this case, respect the maximum allowed distance between LAN adapter and router, which is 50 m in case of Cat5e cables, and 100 m in case of Cat6 cables.
- (b) Recommended strip length: 6 mm
- (c) Recommended strip length: 6 mm
- (d) Recommended strip length: 7 mm. For more information, see "4.2.4 Digital outputs" on page 4.

4.2.1 Router

For the LAN adapter to be connected to a router, that router requires a free LAN port.

The minimum category for the Ethernet cable is Cat5e.

4.2.2 Indoor unit

For power and communication with the indoor unit, the LAN adapter is to be connected to the indoor unit via a 2-wire cable. There is NO separate power supply: the adapter gets its power from the indoor unit.

4.2.3 Electrical meter

If the LAN adapter is connected to an electrical pulse meter (field supply), make sure the meter meets the following requirements:

Item	Specification
Type	Pulse meter (5 V DC pulse detection)

Item		Specification
Possible number of pulses		<ul style="list-style-type: none"> ▪ 0.1 pulse/kWh ▪ 1 pulse/kWh ▪ 10 pulse/kWh ▪ 100 pulse/kWh ▪ 1000 pulse/kWh
Pulse duration	Minimum On time	40 ms
	Minimum OFF time	100 ms
Measurement type		Depends on the installation: <ul style="list-style-type: none"> ▪ Single-phase AC meter ▪ Three-phase AC meter (balanced loads) ▪ Three-phase AC meter (unbalanced loads)

4.2.4 Digital outputs

Connector X1A is for the connection of the LAN adapter to the digital outputs of a solar inverter / energy management system, and allows for use of the Altherma system in various Smart Grid applications.

X1A/N+L are for the supply of a detection voltage to X1A. The detection voltage enables the detection of the state (open or close) of the digital outputs, and does NOT supply power to the rest of the PCB.

ALWAYS install a fuse to the wiring that provides the detection voltage. Fuse requirements: rated current 100 mA~6 A (unless otherwise stated by the applicable legislation).

The rest of the wiring to X1A differs depending on the Smart Grid application. For more information, see the installer reference guide.

5 Installation

5.1 Mounting the LAN adapter

The LAN adapter is mounted to the wall by way of the mounting holes (a) in the rear casing. Before mounting the rear casing to the wall, you have to remove some knockout holes, depending on the direction from which you want the electrical wiring to enter the adapter:

- **Wiring from the bottom:** remove the knockout holes in the bottom of the casing (b) and replace them with the grommets delivered in the accessory bag.
- **Wiring from the rear:** remove the knockout holes in the rear of the casing (c).

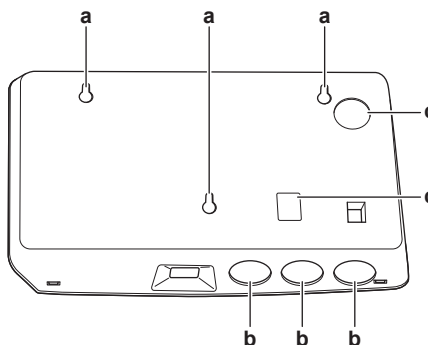

- a Mounting holes
- b Bottom knockout holes
- c Rear knockout holes

i INFORMATION

Wiring from the bottom. Always replace any removed knockout holes with the grommets delivered in the accessory bag. Before inserting the grommets into the holes, cut them open with a utility knife, so that you can let the wiring enter the adapter through the grommets. The grommets **MUST** be inserted into the holes before you insert the wiring into the adapter.

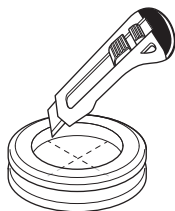

5.1.1 To mount the rear casing to the wall

- 1 Hold the rear casing against the wall and mark the position of the holes.
- 2 Drill the holes.

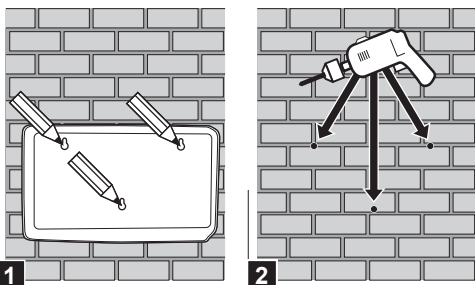

- 3 Mount the rear casing to the wall with the screws and plugs from the accessory bag.

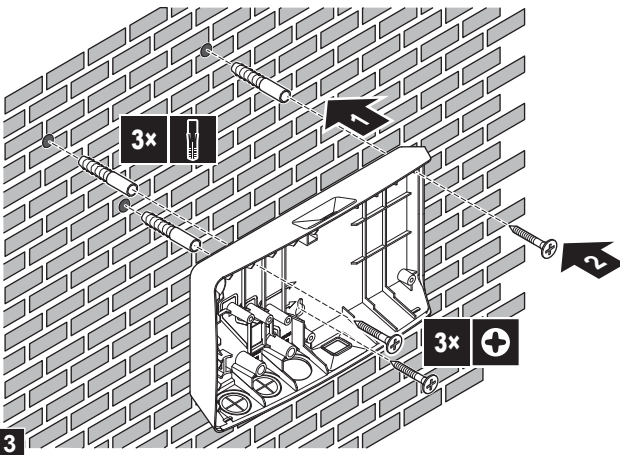

5.1.2 To mount the PCB to the rear casing

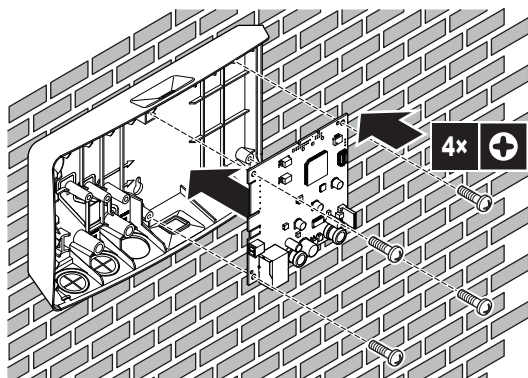

! NOTICE: Risk of electrostatic discharge

Before mounting the PCB, touch an earthed part (a radiator, the casing of the indoor unit, ...) to eliminate static electricity and protect the PCB from damage. Only handle the PCB by its sides.

5.2 Connecting the electrical wiring

! DANGER: RISK OF ELECTROCUTION

Do NOT turn on the power supply (both the power supplied by the indoor unit to X3A and the detection voltage supplied to X1A) before you have connected all the wiring and closed the adapter.

! NOTICE

To prevent damage to the PCB, it is NOT allowed to connect the electrical wiring with the connectors already connected to the PCB. First connect the wiring to the connectors, then connect the connectors to the PCB.

5.2.1 To connect the indoor unit

i INFORMATION

- In the indoor unit switch box, the cable is connected to the same terminals the user interface is connected to. For more information, see the installation manual of the indoor unit.
- The two wires from the cable are NOT polarised. When connecting them to the terminals, their polarity does NOT matter.

- 1 When entering the wiring from the bottom: inside the LAN adapter casing, ensure strain relief by routing the cable along the indicated cable path.
- 2 Connect indoor unit terminals X5M/1+2 to LAN adapter terminals X3A/1+2.

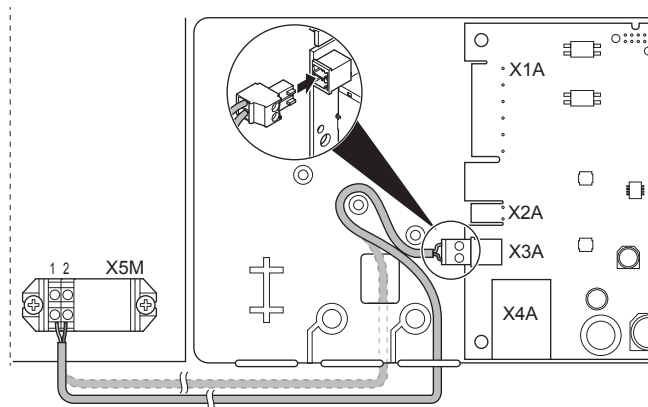

5 Installation

5.2.2 To connect the router

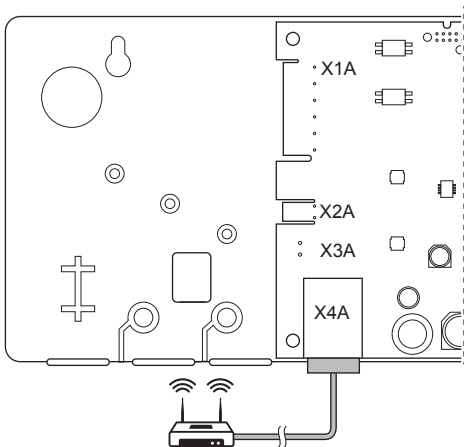

NOTICE

To prevent communication problems due to cable breakdown, do NOT exceed the minimum bend radius of the Ethernet cable.

5.2.3 To connect the electrical meter

INFORMATION

This connection is only supported by LAN adapter BRP069A61.

- When entering the wiring from the bottom: inside the LAN adapter casing, ensure strain relief by routing the cable along the indicated cable path.
- Connect the electrical meter to LAN adapter terminals X2A/1+2.

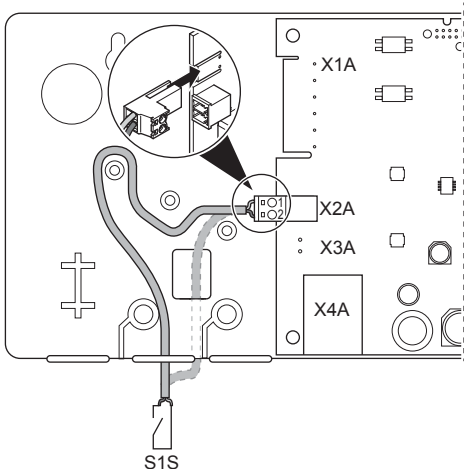

INFORMATION

Mind the polarity of the cable. The positive wire MUST be connected to X2A/1; the negative wire to X2A/2.

INFORMATION

Make sure to connect the electrical meter in the correct direction so that it measures the correct energy flow, according to the desired application.

5.2.4 To connect the digital outputs

INFORMATION

This connection is only supported by LAN adapter BRP069A61.

INFORMATION

How the digital outputs are connected to X1A depends on the Smart Grid application. The connection described in the instructions below is for the system to run in the "Recommended ON" operation mode. For more information, see the installer reference guide.

WARNING

A fuse MUST be installed to the wiring that provides the detection voltage. Fuse requirements: rated current 100 mA~6 A (unless otherwise stated by the applicable legislation).

WARNING

When connecting the wiring to LAN adapter terminal X1A, make sure each wire is securely fastened to the appropriate terminal. Use a screwdriver to open the wire clamps.

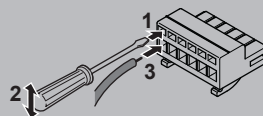

- When entering the wiring from the bottom: ensure strain relief by fastening the cable with a cable tie to the cable tie mounting.
- Provide a detection voltage to X1A/N+L.
- Install a fuse to the wiring that provides the detection voltage.
- For the system to run in the "Recommended ON" operation mode (Smart Grid application), connect the digital output to the X1A/1+2 LAN adapter digital input.

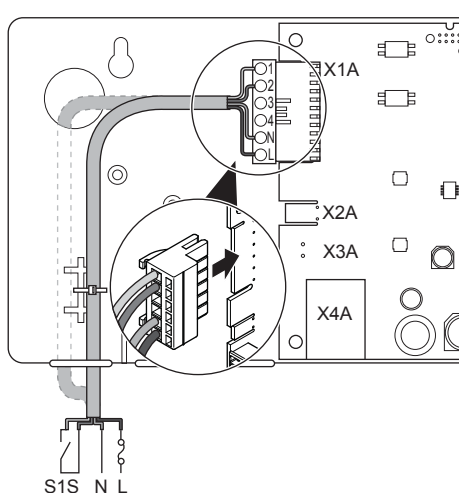

5.3 Finishing the LAN adapter installation

5.3.1 LAN adapter serial number

Before closing the LAN adapter, note down its serial number. This number can be found on the adapter's Ethernet connector (bottommost number on X4A). Note it down in the table below.

Serial number

--

INFORMATION

The serial number is used during the configuration of the LAN adapter. For more information, see the installer reference guide.

5.3.2 To close the LAN adapter

- 1 Click the front casing into the rear casing.

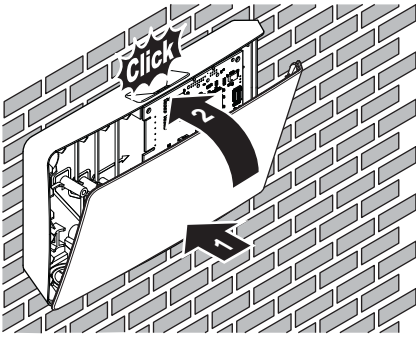

6 Starting up the system

For instructions on how to configure the system, refer to the installer reference guide.

ERC



4P463935-1 A 00000000

Copyright 2016 Daikin

DAIKIN EUROPE N.V.

Zandvoordestraat 300, B-8400 Oostende, Belgium

4P463935-1A 2016.10